



ELIO® Fiber Optic Technology
EN4531, ABS1213, ABS1379, ARINC 801



Presentation

Today's technology for Airborne & Military equipment is more and more complex, requiring the management of an increasing flow of information at greater speeds combined with the necessity to save weight.

In response to this need, SOURIAU offers a wide range of copper and fiber optic solutions for high speed networks in harsh environments.

Fiber optic is the best solution when high data-rate, EMI immunity and weight savings are required.

The ELIO® terminus can handle data speeds from several Mbit/s up to several Gbit/s thanks to its excellent optical performance in the most severe environments. Its unique user-friendly design and its versatility accounts for the selection of ELIO® by major customers in various markets for their fiber optic applications.

Contents

Overview

Typical applications	06
Features & Benefits	07
ELIO® Fiber Optic technologies overview	08

Product Series

ELIO® contact: Technical features	12
ELIO® multimode:	
Ordering information & dimensions	13
MIL-DTL-38999 Series III/EN3645	14
ARINC 600 Series	19
ELIO® singlemode:	
Ordering information & dimensions	21
MIL-DTL-38999 Series III/EN3645	22
Backshells	25
Harnesses & Patchcords	28

Tooling & Accessories

Insertion & Extraction tool	34
Filler plug & Dummy contact	34
ELIO® adaptor for ST polishing fixture	34
ELIO® coupler	35
ELIO® mechanical splice	35
Universal test connector	35
ELIO® end face inspection tool	36
ELIO® blind inspection tool	37
ELIO® cleaning tool	37

Range Extension

8XE Series with ELIO® contacts	40
VGE1 Series with ELIO® contacts	40
8D hermetic ELIO® feedthrough	41
Optical connectors website	42
ELIO® training	42

ELIO® FIBER OPTIC

Overview

■ Typical applications	6
■ Features & Benefits	7
■ Soriau ELIO® Fiber Optic technologies overview	8



Typical applications



Civil Aeronautics



Ground Army



Military Aircraft



Rotary Wing



Railway and Industrial



Marine

Features & Benefits

IP67

Sealed Technology

IP67 without backshell.

ROBUST

Ruggedized Physical Contact

Flight proven A380.
Standardized worldwide (EN4531, Airbus qualified).
Withstanding the most severe vibration levels (A400M qualified).

**USER
FRIENDLY**

Easy to Clean

Easy access to the end face of both male and female contacts:
- No risk to damage the sleeve when cleaning.
- No risk to capture dust inside the sleeve cavity.

**EASY TO
INSTALL**

Tool Free

Easy contact insertion with 1/4 turn bayonet.

**READY
IN 5 MIN**

Easy to Terminate

- Hermaphroditic terminus (same in receptacle and plug).
- ST®-like assembly process.

SOURIAU ELIO® fiber optic

Aerospace standards

MIL-DTL-38999 / EN3645 / EN3646



Rectangular connectors

ARINC 600 / 809 / 404 & DOD



Railway

VGE1



Industrial

8XE



ELIO® fiber optic

Singlemode or Multimode contact

+ ELIO® can fit in many connector types



Standard #8 Quadrax cavity adaptor

- ▶ ELIO® contact can fit in any #8 Quadrax cavity
- ▶ Many optical/electrical hybrid layouts available



technologies overview



Hermetic

10⁻⁹ atm.cm³/s



Reinforced sealing

Lighweight



Rack & panel

8LT



Lanyard release

8D36



A complete optical solution

- ▶ **Backshells:** Souriau has developed a dedicated backshell range to ensure the best optical performance
- ▶ **Harnesses and Patchcords:** Souriau offers support from design through manufacturing



ELIO® FIBER OPTIC

Product Series

■ ELIO® multimode & singlemode contacts: Technical features	12
■ ELIO® multimode:	
Contact ordering information & dimensions	13
MIL-DTL-38999 Series III/EN3645 with ELIO® high density insert	14
MIL-DTL-38999 Series III/EN3645 with ELIO® AQ Adaptor for #8 cavities	16
ARINC 600 Series with ELIO® AQ Adaptor for #8 cavities	19
■ ELIO® singlemode:	
Contact ordering information & dimensions	21
MIL-DTL-38999 Series III/EN3645 with ELIO® high density insert	22
MIL-DTL-38999 Series III/EN3645 with ELIO® AQ Adaptor for #8 cavities	23
■ Backshells	25
■ Harnesses & Patchcords	28

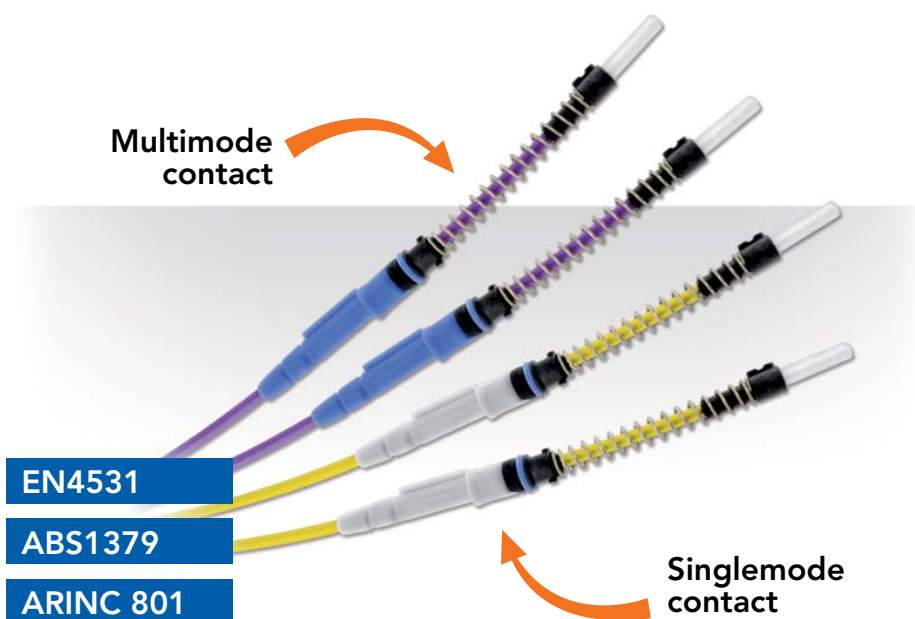

ELIO® contacts multimode & singlemode

- Robust spring-loaded butt-joint optical contact using ST style ferrule (diameter 2.5mm)
- Contact size equivalent to a #16 contact
- Anti-rotation of the contact for better vibration withstanding and optical performance
- Boot-grommet for rear sealing and protection of the cable against excessive bending
- Compatibility with loose and tight structure cables
- High level optical performance even after aging
- Bayonet locking system: no tool needed for mounting/dismounting
- Compatible with singlemode, multimode and POF cable

Technical features

Mechanical

- **Endurance:**
Minimum 500 mating/unmating operations
- **Shock:**
300 g, 3 ms as per EN 2591-6402 method A
- **Vibration:**
In MIL-DTL-38999 Series III/EN3645 connectors:
- Sine 5Hz to 3000Hz as per EN2591-6403 method A
- Random as per EN2591-6403 method B
- **Cable cyclic flexing*:**
100 cycles, load 40N as per EN2591-609
- **Cable pulling*:** 111N
- **Cable torsion*:**
100 cycles, load 40N as per EN2591-611

Environmental

- **Salt spray:**
See the connector standard
- **Temperature range*:**
- 65°C to +125°C (1000 hours)

- **Rapid temperature change:**
10 cycles - 65°C / +150°C (30min/30min)
- **Air leakage:**
Max leakage 16 cm³/h, 2 hours, 40kPa differential pressure
- **Damp heat and low temperature:**
5 cycles of 48h -65°C/+70°C with stage at 40°C with 95% of humidity as per EN2591- 6303 method A

Optical

- **Multimode contact - Insertion Loss (IL):**
0.1dB typical
< 0.3dB over 95% of the samples as per EN2591-601,
< 0.7dB maximum on 100% of the samples after tests
- **Multimode contact - Return Loss (RL):**
> 21dB before and after tests as per EN2591-605
- **Singlemode contact - Insertion Loss (IL):**
0.3dB typical
< 0.5dB over 95% of the samples as per EN2591-601,
< 0.9dB maximum on 100% of the samples after tests
- **Singlemode contact - Return Loss (RL):**
> 55dB typical and > 50dB minimum

Resistance to fluids as per MIL-DTL-38999/EN3645 standard

- **Fuel:** JP5
- **Mineral Hydraulic fluid:**
MIL-PRF-5606 (NATO H-515)
- **Synthetic hydraulic fluid:**
AS1241 (Skydrol 500B4, LD4)
- **Mineral lubricant:**
MIL-PRF-7870 (NATO O-142)
- **Synthetic lubricant:**
MIL-PRF-23699 (NATO O-156),
MIL-PRF-7808 (NATO O-148)
- **Cleaning fluid:**
MIL-PRF-87937 diluted, Propanol, white spirit, Azeotrope R113 + Methanol
- **De-icing fluid:**
AMS 1424 (NATO S-742)
- **Extinguishing fluid:**
Chlorobromethane
- **Cooling fluid:**
Coolanol

* With multimode EN4641-100 cable and following the cabling process described in the "Technical Bulletin N°204 - ELIO® assembly wiring instructions" and the maintenance procedure in the document "Technical Bulletin N°170 - Fiber optics installation and maintenance procedure".

ELIO® multimode contact Ordering information

ELIO	09N	G	L	A
Cable external diameter & Contact sealing:				
09N: 0.9 ^{±0.1} mm. Non waterproof				
18N: from 1.5mm to 1.9mm. Non waterproof				
18W: 1.8 ^{±0.1} mm. Waterproof				
20N: from 1.7mm to 2.1mm. Non waterproof				
20W: 2.0 ^{±0.1} mm. Waterproof				
Fibre type:				
G: ELIO® Multimode fibre, 125 micrometers cladding				
Boot type:				
L: Long boot				
S: Short boot				
N: No boot (non waterproof version only)				
Contact version index				



Note: For ABS1379/EN4531 cross reference, please consult us.

ELIO® contact dimensions

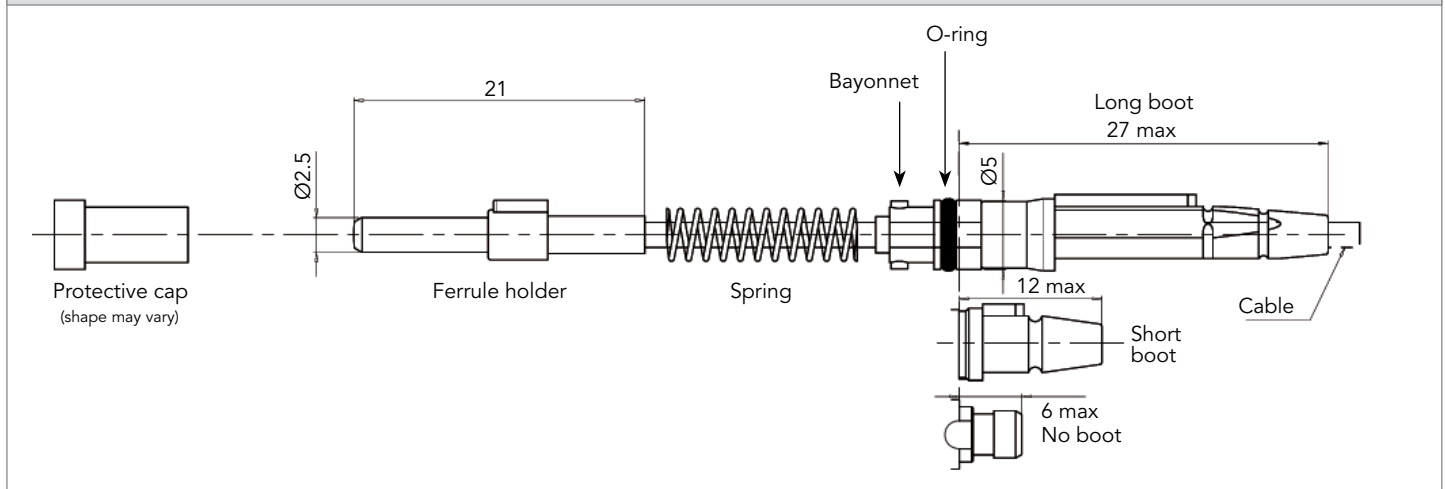

Recommended cables

SOURIAU can offer a wide range of cables in its assemblies, from low cost to high performance aeronautical cables. ELIO® contact is compatible with singlemode and multimode cable, with tactical and breakout cable. ELIO® contact is suitable with loose and tight structure cable.

See "Harnesses & Patchcords" page 28.

Note: All dimensions are in millimeters (mm)

**MIL-DTL-38999
Series III/EN3645
ELIO® high density insert
with multimode contact**

- Standard MIL-DTL-38999/EN3645 shells without shielding ring (aluminum, composite, stainless steel, bronze)
- Environmental performance as per EN4531 based on MIL-DTL-38999/EN3645
- Temperature range: - 65°C to +125°C (cable limitation)

EN4531

ABS1213

ARINC 801

Applications

- Fiber optic connector for all military and aeronautical applications wherever severe vibration or mechanical resistance are required:
 - Ground army,
 - Civil aircraft,
 - Marine,
 - Military aircraft,
 - Rotary wing

Layouts

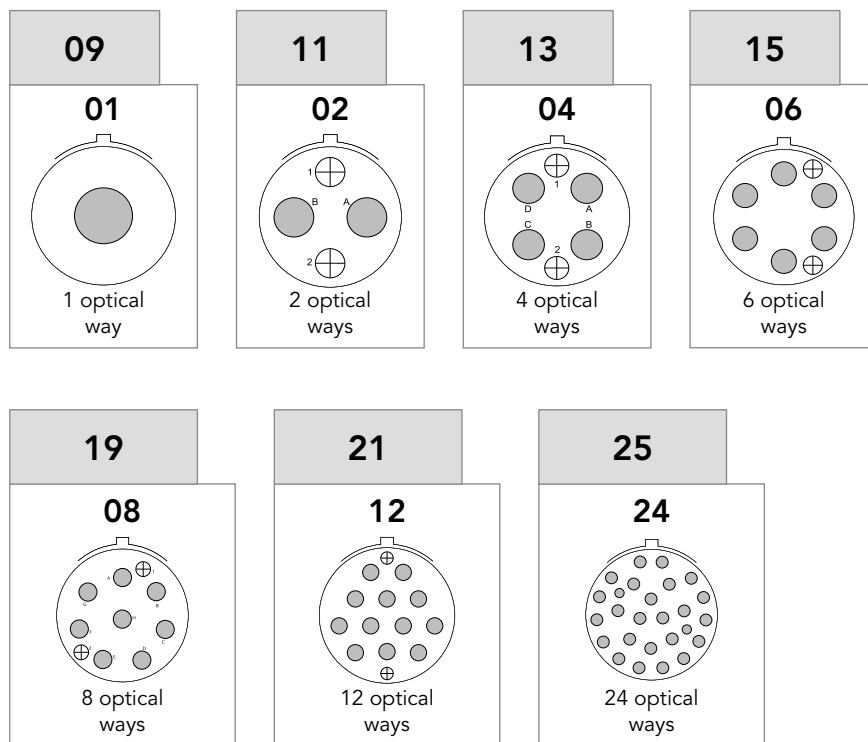

Note: Layout 15-06 limited availability, please consult us.

ELIO® high density insert with multimode contact

Ordering information - Connectors delivered without contact

Composite, Aluminum & Stainless Steel

	8D	5	E	11	W	02	A	N
	8D	5	E	11	W	02	B	N
Shell type:								
5: Plug								
0: Receptacle with 4-hole square flange fixing								
7: Receptacle with single hole jam nut fixing (aluminum & stainless steel)								
Designation:								
E: ELIO® optical connector								
Shell size:								
09 - 11 - 15 - 13 - 19 - 21 - 25								
Plating:								
Aluminum:			Composite:			Stainless steel:		
Z: Zinc nickel			J: Olive green cadmium			K: Passivated		
ZC: Zinc cobalt			M: Nickel			S: Nickel		
W: Olive green cadmium			X: Without plating					
F: Nickel								
Layouts: See previous page								
Insert type:								
A: Male insert								
B: Female insert with ceramic alignment sleeves								
Polarization:								
N, A, B, C, D, E								

JVS Bronze

	JVS	E	6	A	11	02	A	N
	JVS	E	6	A	11	02	B	N
Designation:								
E: ELIO® optical connector								
Shell type:								
6: Plug								
0: Receptacle with 4-hole square flange fixing								
7: Receptacle with single hole jam nut fixing								
Material:								
A: Bronze								
Shell size: 09 - 11 - 15 - 13 - 19 - 21 - 25								
Layouts: See previous page								
Insert type:								
A: Male insert								
B: Female insert with ceramic alignment sleeves								
Polarization: N, A, B, C, D, E								

Dimensions

See pages 17 & 18.

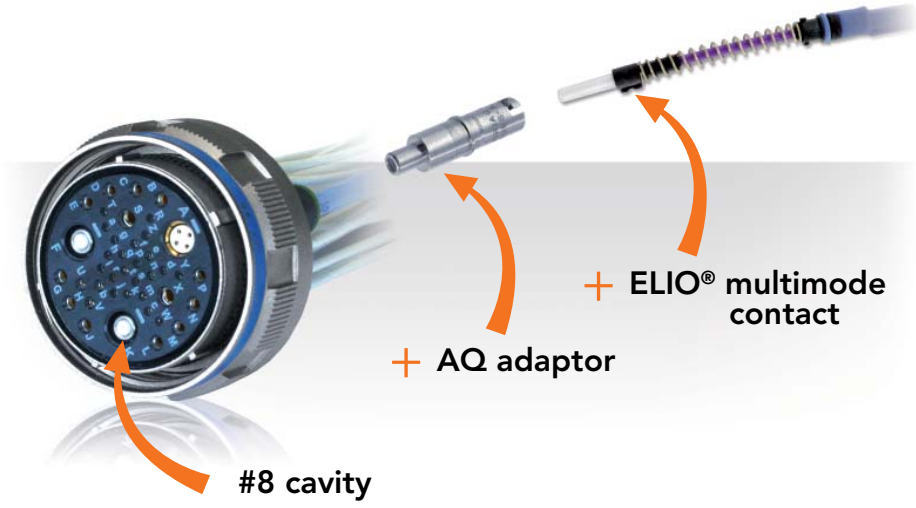



MIL-DTL-38999 Series III/EN3645 with ELIO® multimode contact and ELIO® AQ Adaptor for Quadrax #8 cavities

- ELIO® AQ is an adaptor to enable the ELIO® contact to fit in any #8 cavities
- Multiple possibilities to mix optical and electrical signals in the same insert
- Compatible with standard MIL-DTL-38999 Series III/EN3645 connectors (aluminum, composite, stainless steel, bronze)
- Design ensures ELIO® optical performance
- Environmental performance as per MIL-DTL-38999 and EN3645 standard
- Temperature range: - 65°C to +150°C (cable limitation)

Applications

- Fiber optic connector for all military and aeronautical applications wherever severe vibration or mechanical resistance are required.

ELIO® AQ Adaptor for Quadrax #8 cavities

Insert type	Part Number
Male Insert	 ELIOAQ6PB
female Insert	 ELIOAQ6SB

Delivered with alignment boot.

Ordering information

See SOURIAU «8D Series - MIL-DTL-38999 Series III» catalog.

Dimensions

See pages 17 & 18.

Layouts

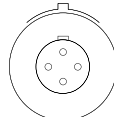
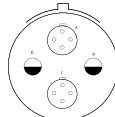
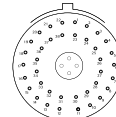
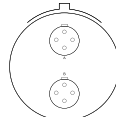
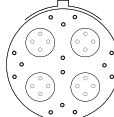
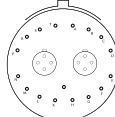
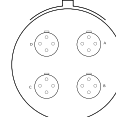
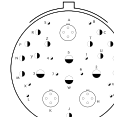
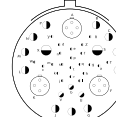
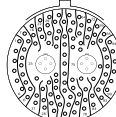
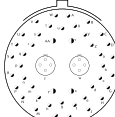
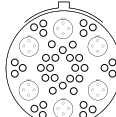
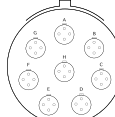
11					
81	80	81	82		
 1 #8	 2 #12 2 #8	 38 #22D 1 #8	 2 #8		
19					
84	21				
 14 #22D 4 #8	 17 #22D 2 #8	 4 #8			
25					
80	81	82	86	87	88
 10 #20 13 #16 4 #12, 3 #8	 22 #22D 3 #20, 11 #16 2 #12, 3 #8	 97 #22D 2 #8	 40 #20 4 #16 2 #8	 36 #22D 6 #8	 8 #8

Dimensions

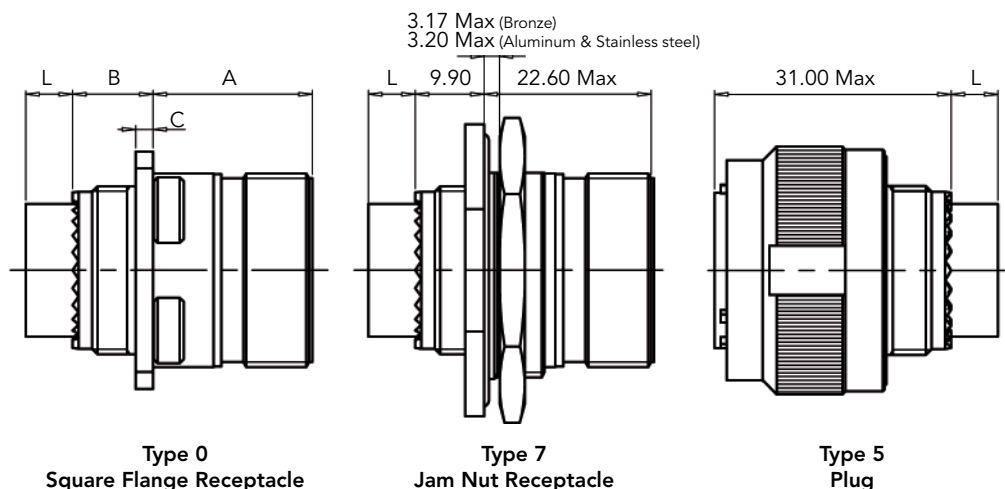

	A		B		C		L	
	Shell size 09 to 19	Shell size 25	Shell size 09 to 19	Shell size 25	Shell size 09 to 19	Shell size 25	Male insulator	Female insulator
Receptacle Type 0 & 7 Metal	20.90 Max	20.10 Max	12.50 Max	13.00 Max	2.50 Max	3.20 Max	4 Max	6.60 Max
Receptacle Type 0 Composite	20.90 Max	20.10 Max	12.50 Max	13.00 Max	3.65 Max	4.35 Max		

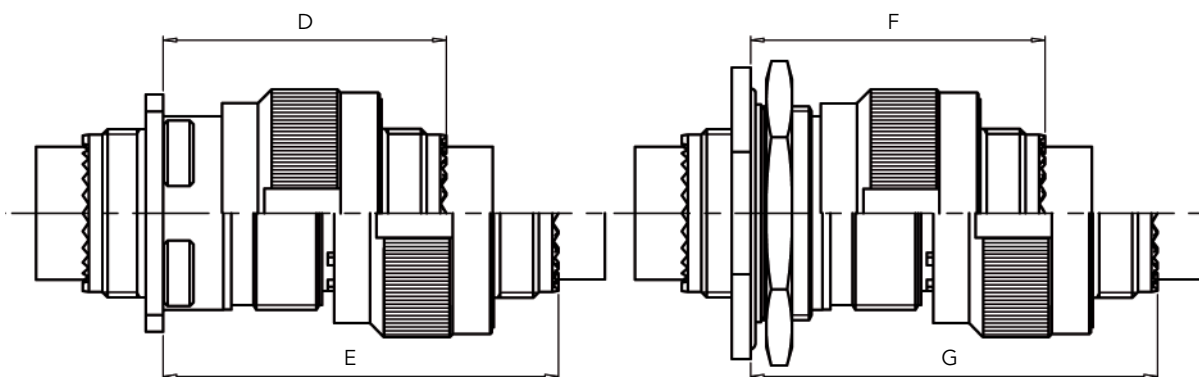

	D		E		F		G	
	Shell size 09 to 19	Shell size 25	Shell size 09 to 19	Shell size 25	Shell size 09 to 11	Shell size 13 to 25	Shell size 09 to 11	Shell size 13 to 25
Plug + Receptacle Type 0 & 7 Metal	37.00 Max	36.50 Max	52.30 Max	51.50 Max	39.00 Max	39.00 Max	54.00 Max	54.00 Max
Plug + Receptacle Type 0 Composite	37.00 Max	36.50 Max	52.30 Max	51.50 Max	N/A	N/A	N/A	N/A

Note: All dimensions are in millimeters (mm)

Dimensions

38999 Series III/EN3645 with ELIO® contacts in ELIO® high-density insert

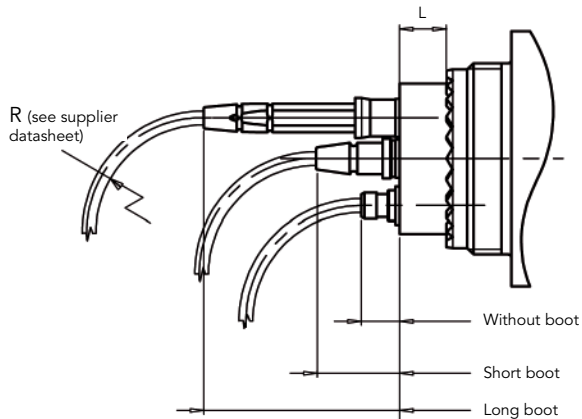

38999 Series III/EN3645 with ELIO® contacts in ELIO® AQ adaptors

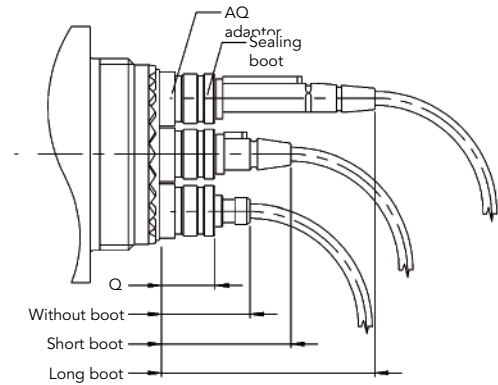

	ELIO® high density insert					ELIO® AQ adaptors							
	L		Contact length			Q		Contact length					
	Male insulator	Female insulator	Without boot	Short boot	Long boot	Male insulator	Female insulator	Long boot		Short boot		Without boot	
								Male insulator	Female insulator	Male insulator	Female insulator	Male insulator	Female insulator
Plug					12 Max	9.5 Max	34.5 Max	32 Max	19.5 Max	17 Max	12.5 Max	10 Max	
Square flange receptacle	4 Max	6.60 Max	6 Max	12 Max	27 Max	12.5 Max	10 Max	35 Max	32.5 Max	20 Max	17.5 Max	13 Max	10.5 Max
Jam nut receptacle						12 Max	9.5 Max	34.5 Max	32 Max	19.5 Max	17 Max	12.5 Max	10 Max

Total length example

Square flange receptacle + plug + ELIO® contacts in ELIO® high-density insert

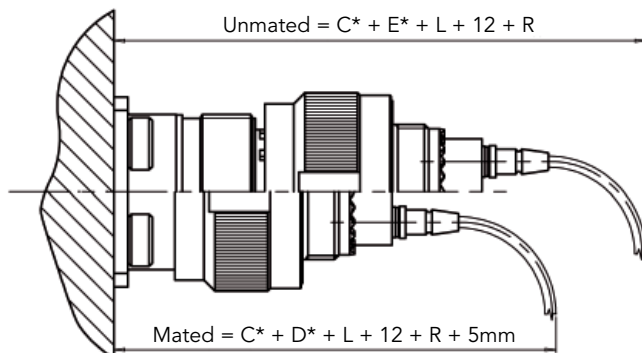

* See previous page.

Note: All dimensions are in millimeters (mm)

ARINC 600 Series with ELIO® multimode contact and ELIO® AQ Adaptor for Quadrax #8 cavities

- Compatible with standard ARINC 600 Souriau connector
- Designed to ensure ELIO® contact optical performances
- Many possibilities to mix optical and electrical contact
- Temperature range: -65°C to +125°C (cable limitation)

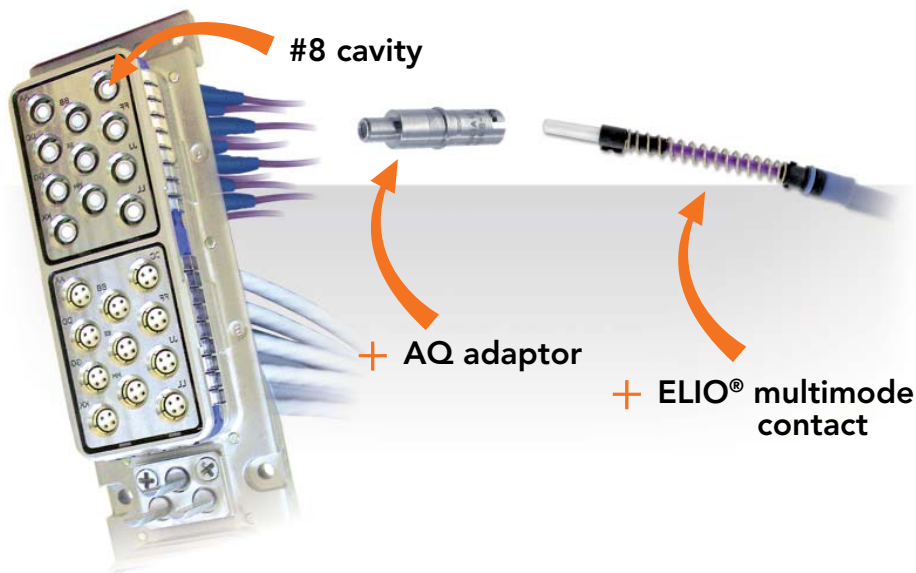



Applications

- Fiber optic connector for all military and aeronautical applications wherever severe vibration or mechanical resistance are required.

ELIO® AQ

Adaptor for Quadrax #8 cavities

Insert type	Part Number
Male Insert	 ELIOAQ0P (rear release - delivered with alignment boot)
	 ELIOAQ1P (front release)
Female Insert	 ELIOAQ0S (rear release)

Dimensions



See page 20.

Ordering information





See Souriau «ARINC 600 Series» catalog.

Layouts

ARINC 600 shell size 2 & 3

Cavity A, B, D & E		
 Q11* 11 #8	 118Q2 118 #22 2 #8	 C12Q6* 12 #12 6 #8

* Grounded metal insert

Cavity C & F				
 Q6* 6 #8	 68Q2 68 #22 2 #8	 11Q2 4 #20, 3 #16 4 #12, 2 #8	 62Q2 60 #22 2 #16, 2 #8	 20Q4 20 #20 4 #8

Dimensions

ARINC 600 with ELIO® contacts in ELIO® AQ adaptors

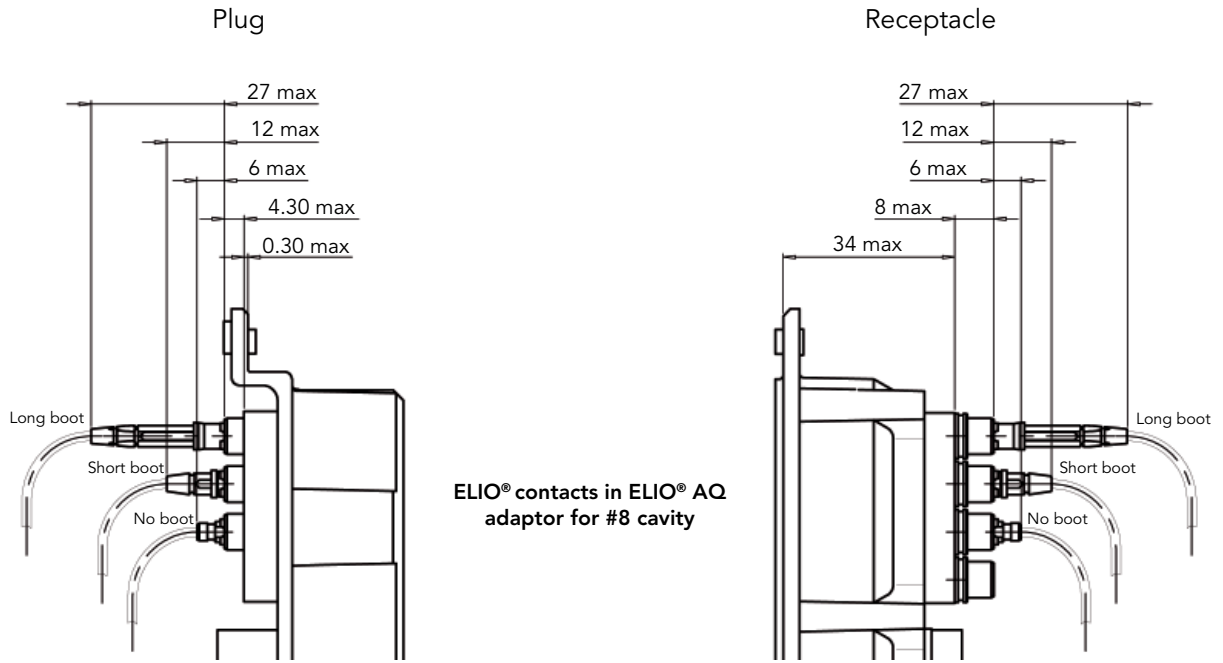

Note: All dimensions are in millimeters (mm)

ELIO® singlemode contact Ordering information

ELIO	09N	E	L	A
Cable external diameter & Contact sealing:				
09N: 0.9 ^{±0.1} mm. Non waterproof				
18N: from 1.5mm to 1.9mm. Non waterproof				
18W: 1.8 ^{±0.1} mm. Waterproof				
20N: from 1.7mm to 2.1mm. Non waterproof				
20W: 2.0 ^{±0.1} mm. Waterproof				
Fibre type:				
E: ELIO® Singlemode 9/125, PC polish				
Boot type:				
L: Long boot				
S: Short boot				
N: No boot (non waterproof version only)				
Contact version index				



ELIO® contact dimensions

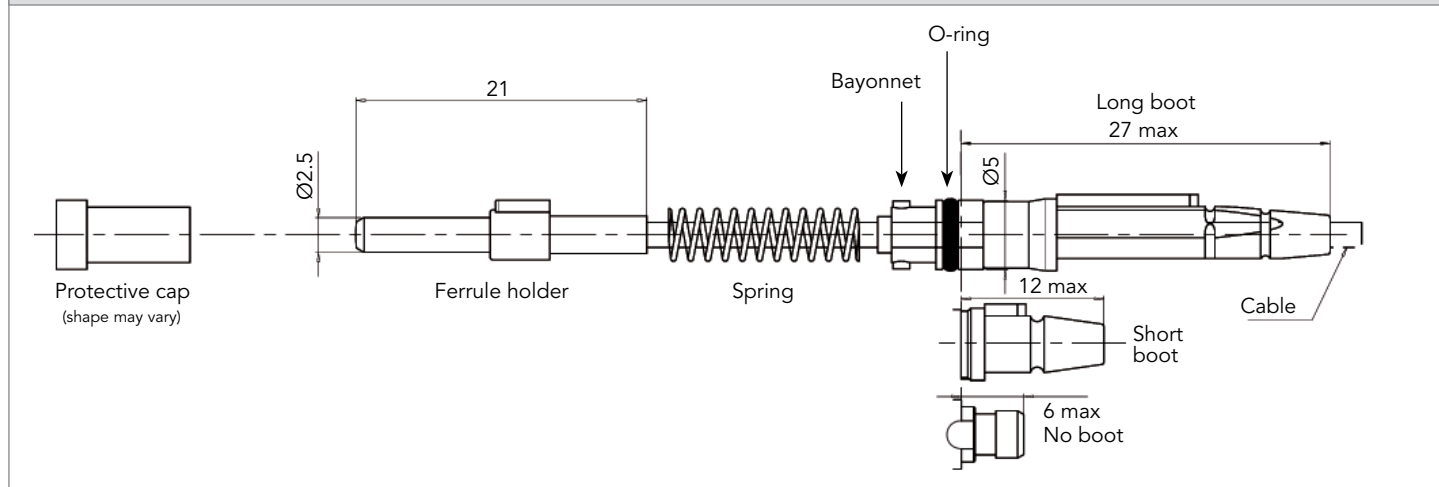

Recommended cables

SOURIAU can offer a wide range of cables in its assemblies, from low cost to high performance aeronautical cables. ELIO® contact is compatible with singlemode and multimode cable, with tactical and breakout cable. ELIO® contact is suitable with loose and tight structure cable.

See "Harnesses & Patchcords" page 28.

Note: All dimensions are in millimeters (mm)



EN4531

ARINC 801

**MIL-DTL-38999
Series III/EN3645
ELIO® high density insert
with singlemode contact**

- Standard MIL-DTL-38999/EN3645 shells without shielding ring (aluminum, composite, stainless steel, bronze)
- Environmental performance as per EN4531 based on MIL-DTL-38999/EN3645
- Temperature range: - 65°C to +125°C (cable limitation)

Applications

- Fiber optic connector for all military and aeronautical applications wherever severe vibration or mechanical resistance are required:
 - Ground army,
 - Civil aircraft,
 - Marine,
 - Military aircraft,
 - Rotary wing

Layouts

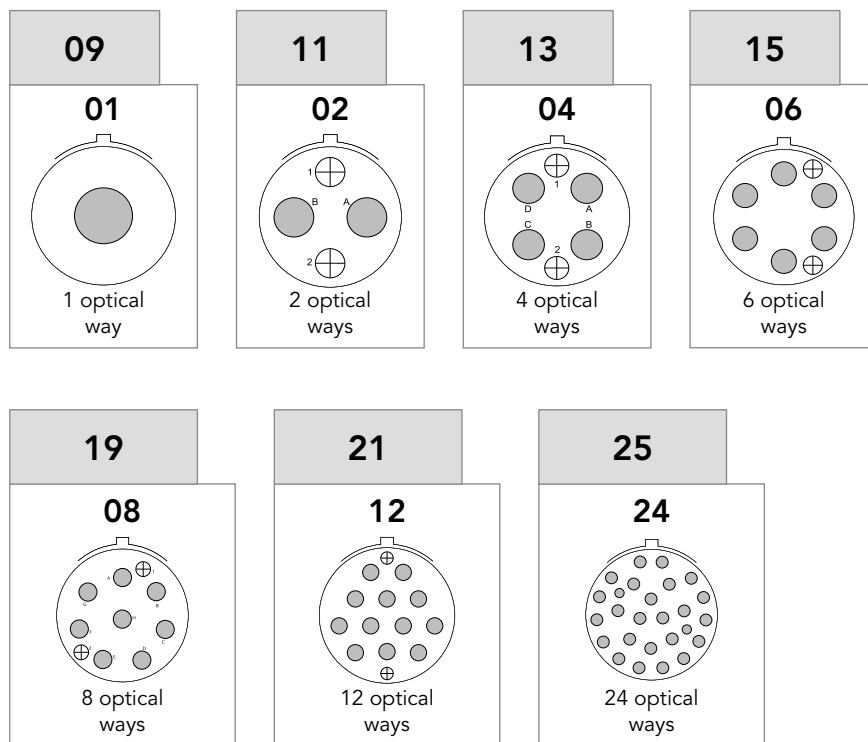

Note: Layout 15-06 limited availability, please consult us.

ELIO® high density insert with singlemode contact

Ordering information - Connectors delivered without contact

Composite, Aluminum & Stainless Steel

	8D	5	E	11	W	02	A	N	674
	8D	5	E	11	W	02	B	N	
Shell type:									
5: Plug									
0: Receptacle with 4-hole square flange fixing									
7: Receptacle with single hole jam nut fixing (aluminum & stainless steel)									
Designation:									
E: ELIO® optical connector									
Shell size:									
09 - 11 - 15 - 13 - 19 - 21 - 25									
Plating:									
Aluminum:			Composite:			Stainless steel:			
Z: Zinc nickel			J: Olive green cadmium			K: Passivated			
ZC: Zinc cobalt			M: Nickel			S: Nickel			
W: Olive green cadmium			X: Without plating						
F: Nickel									
Layouts: See previous page									
Insert type:									
A: Male insert									
B: Female insert with ceramic alignment sleeves - Specification 674 mandatory									
Polarization:									
N, A, B, C, D, E									
Specification:									
empty: Male insert type A									
674: Female insert type B - mandatory									

JVS Bronze

	JVS	E	6	A	11	02	A	N	674
	JVS	E	6	A	11	02	B	N	
Designation:									
E: ELIO® optical connector									
Shell type:									
6: Plug									
0: Receptacle with 4-hole square flange fixing									
7: Receptacle with single hole jam nut fixing									
Material:									
A: Bronze									
Shell size: 09 - 11 - 15 - 13 - 19 - 21 - 25									
Layouts: See previous page									
Insert type:									
A: Male insert									
B: Female insert with ceramic alignment sleeves - Specification 674 mandatory									
Polarization: N, A, B, C, D, E									
Specification:									
empty: Male insert type A									
674: Female insert type B - mandatory									

Dimensions

See pages 17 & 18.

**MIL-DTL-38999
Series III/EN3645
with ELIO® singlemode contact
and ELIO® AQ Adaptor for
Quadrax #8 cavities**

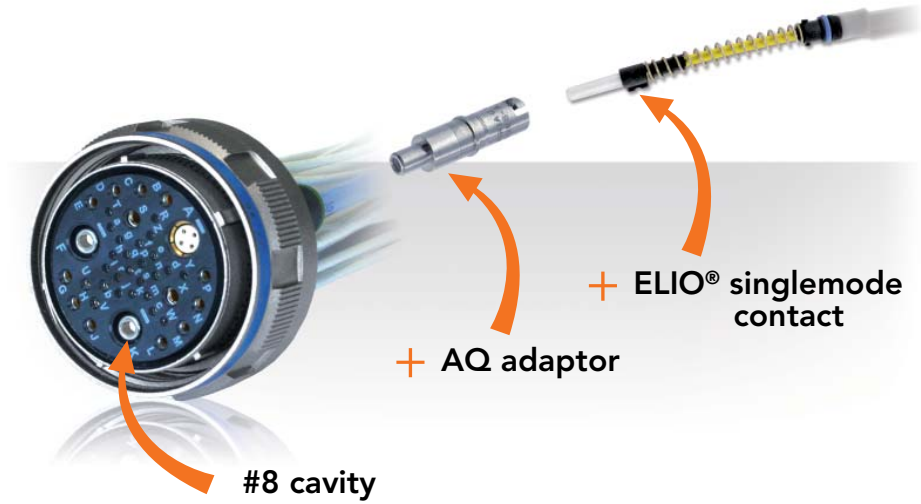

- ELIO® AQ is an adaptor to enable the ELIO® contact to fit in any #8 cavities
- Multiple possibilities to mix optical and electrical signals in the same insert
- Compatible with standard MIL-DTL-38999 Series III/EN3645 connectors (aluminum, composite, stainless steel, bronze)
- Design ensures ELIO® optical performance
- Environmental performance as per MIL-DTL-38999 and EN3645 standard
- Temperature range: - 65°C to +150°C (cable limitation)



Applications

- Fiber optic connector for all military and aeronautical applications wherever severe vibration or mechanical resistance are required.

**ELIO® AQ
Adaptor for Quadrax #8 cavities**

Insert type	Part Number
Male Insert	 ELIOAQ6PB
female Insert	 ELIOAQ6SB674

Delivered with alignment boot.

Ordering information

See Souriau «8D Series - MIL-DTL-38999 Series III» catalog.

Dimensions

See pages 17 & 18.

Layouts

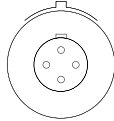
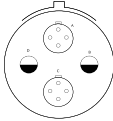
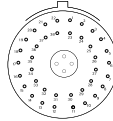
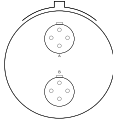
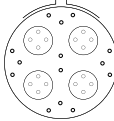
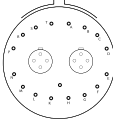
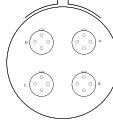
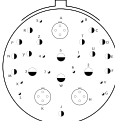
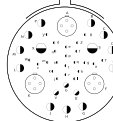
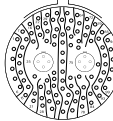
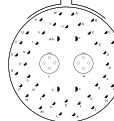
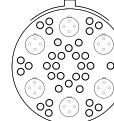
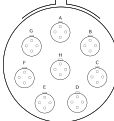
11			17		
81			80	81	82
					
1 #8			2 #12 2 #8	38 #22D 1 #8	2 #8
19			21		
84			78	84	
					
14 #22D 4 #8			17 #22D 2 #8	4 #8	
25					
80	81	82	86	87	88
					
10 #20 13 #16 4 #12, 3 #8	22 #22D 3 #20, 11 #16 2 #12, 3 #8	97 #22D 2 #8	40 #20 4 #16 2 #8	36 #22D 6 #8	8 #8

Description

- The ELIO® contact has a specific mating sequence: the cable moves back during the mating. To avoid the ELIO® mating sequence to be disturbed and to ensure the best optical performances, Souriau has developed a dedicated backshell range for MIL-DTL-38999 Series III/EN3645 ELIO® connectors.
- There are 4 types of backshell available. They are compatible with standard electrical MIL-DTL-38999 Series III/EN3645 rear interface.



Type 1: Adaptor for use with a standard 38999 Series III/EN3645 backshell. Caution is necessary in the choice of the standard backshell: it must allow enough room to accommodate the push back of the cable during the connector mating.



Type 3: Backshell with cable gland suitable for tactical cables only. Adapted to sealed and high mechanical retention applications. See table p.26 for dimension code depending on the shell size and the cable diameter.



Type 2: Backshell for straight or right angled heat shrink boot (not supplied), suitable for tactical cables or protection tubes for example. Adapted to sealed and low mechanical retention applications.



Type 4: Backshell derived from Type 3 without the cable gland. Suitable to adapt specific male threaded adaptors (not supplied) for ANAMET or PMA tubes for example. See table p.27 for the size of the female thread depending on the shell size.

Ordering information

	8DABE	3	A	F	13	F	01
Type:							
1:	Adaptor for standard 38999 Series III/EN3645 backshell (standard backshell not supplied)						
2:	Backshell for straight or right angled heat shrink boot (heat shrink boot not supplied)						
3:	Backshell with cable gland. See table p.26 for dimension code.						
4:	Backshell for specific male threaded adaptor for PMA or ANAMET tubes for example (not supplied). See table p.27 for thread dimensions						
Angle:							
A:	Straight						
	For other angle, please consult us.						
Coupling ring:							
F:	Non self locking type						
	For other system, please consult us.						
Shell size:	09, 11, 13, 19, 25						
Material & Plating:							
Z:	Aluminum black zinc nickel plated						
W:	Aluminum plated with Olive drab cadmium over electroless nickel - Salt spray 500 hours						
F:	Aluminum plated with Electroless nickel						
B:	Bronze						
Dimension code:							
01:	Only for Type 3, see table p.26						
	No digit for other types.						

Backshells - Dimensions

Backshell Type 1

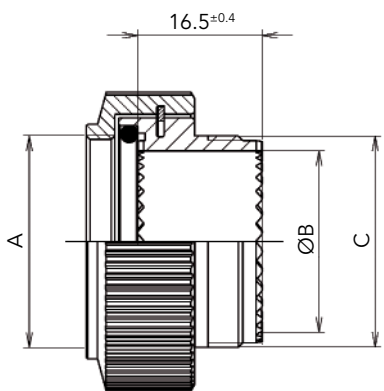

Size	Thread A	ØB ^{±0.25}	Thread C
09	M12x1	8.7	M12x1
11	M15x1	11.7	M15x1
13	M18x1	14.7	M18x1
19	M28x1	24.0	M28x1
25	M37x1	33.2	M37x1

Backshell Type 2

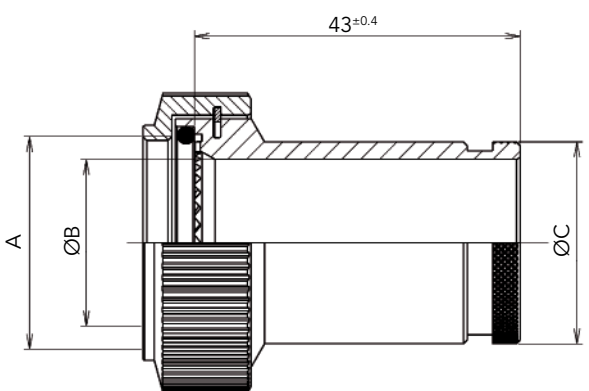

Size	Thread A	ØB ^{±0.25}	ØC ^{±0.2}
09	M12x1	8.7	16.7
11	M15x1	11.7	19.7
13	M18x1	14.7	22.7
19	M28x1	22.0	26.6
25	M37x1	32.2	36.8

Backshell Type 3

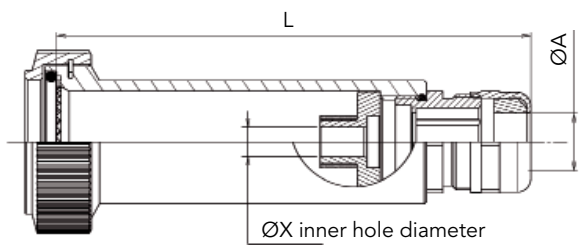
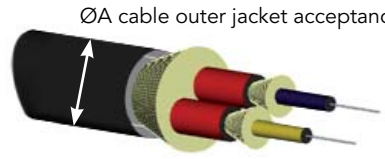
Note: Same marking as Type 4.

Shell size	09			11			13			19			25			
	ØA	DC	L	ØX Max	DC	L	ØX Max	DC	L	ØX Max	DC	L	ØX Max	DC	L	ØX Max
3 to 6 mm		00	101	3.5	00	101	5	00	101	5	00	104	5	00	104	5
5 to 7.8 mm		01	103	3.5												
5 to 8 mm					01	101	5	01	101	7	01	104	7	01	104	7
6 to 10 mm					02	114	5	02	114	7	02	102	11	02	105	11
8 to 11.8 mm					03	114	5	03	115	7						
8 to 12 mm											03	103	11	03	106	11
9.5 to 14 mm											04	116	11	04	104	14
11.5 to 15.8 mm											05	122	11			
11.5 to 18 mm														05	110	14
15 to 20.8 mm														06	130	17

DC = Dimension Code

Note: All dimensions are in millimeters (mm)

Backshell Type 4

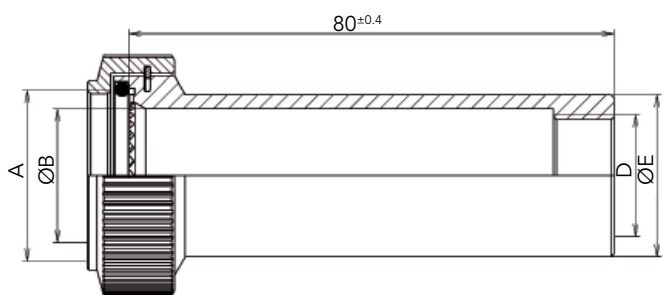

Size	Thread A	ØB±0.25	Thread D	ØE±0.2
09	M12x1	8.7	M12x1.5	16.7
11	M15x1	11.7	M16x1.5	19.7
13	M18x1	14.7	M16x1.5	22.7
19	M28x1	22.0	M20x1.5	26.6
25	M37x1	32.2	M25x1.5	36.8

Total length with backshell

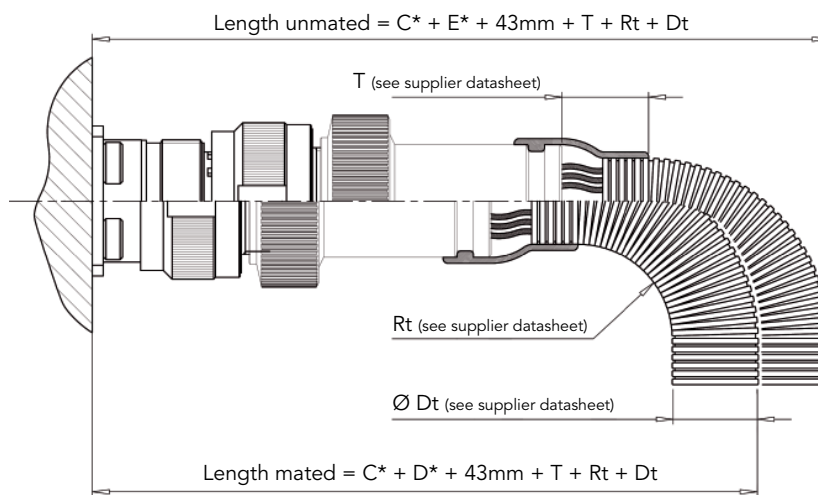

* See page 17

Backshell use examples

Type 2 - heat shrink boot not supplied

- 8DABE2AF13W with a straight boot on PMA tube



- 8DABE2AF13F with a right angled boot on tactical cable



Type 3 - supplied with cable gland

- 8DABE3AF13W01



Type 4 - supplied without the specific adaptor

- 8DABE4AF13W with PMA tube adaptor



Note: All dimensions are in millimeters (mm)

Harnessing

- Military or aerospace jumpers, highly exposed to extreme acceleration, deceleration with shock, vibration and environmental constraints like dust and contaminant, are a perfect example where know-how and experience are key to providing a cost-efficient and sustainable solution.

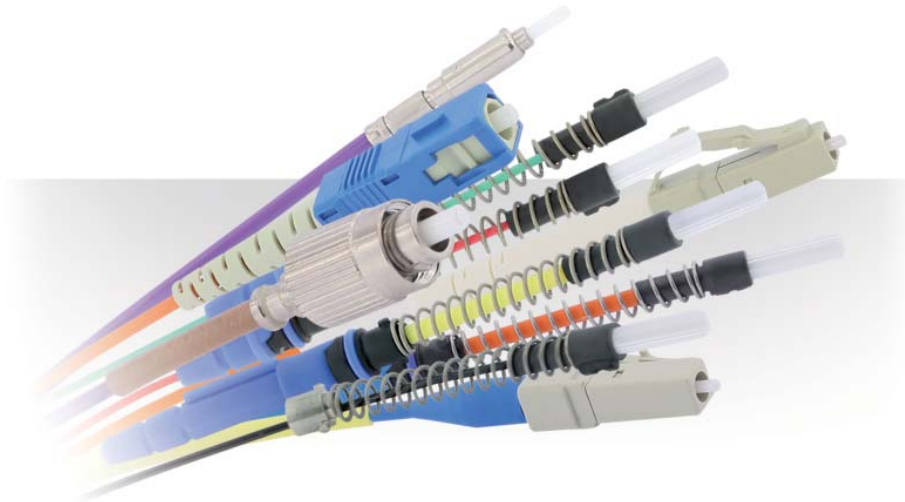

- The dedicated R&D optical team supports your specific needs from pre-project to full industrial release with adapted solutions: Technical and economical analysis with the customer, design and development of optical solution, deployment support (work instruction, field training, installation procedure) and robust after sales support.
- 100% of harnesses and patchcords are tested with interferometer to check the positioning of the fiber inside the ferrule.
- 100% visually inspected under microscope.
- 30 years of experience in designing fiber optics connectors harnesses
- Test lab able to realize mechanical, environmental, climatic tests
- Reactivity: in house production line close to the design office

Interferometry

- Technical measurement that calculates the topography of a surface.

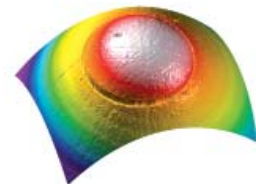

- The system gives in 3 dimensions the observed surface with curves similar to levels of a geographic map. As a result it is possible to get the geometric parameters of the optical contact with an extreme accuracy.

Ordering information

	HA02	XXXX	XXX	M	A
Patchcord combination code: XXXX: See tables p.29 to 31					
Patchcord length: In meter when possible. Examples: - for a 3 meter assembly, use 003(M) and not 300(CM) - for a 3.5 meter assembly, use 350(CM)					
Length unit: M: Meter CM: Centimeter					
Patchcord version index					

Note: To create your patchcord part number, select your patchcord combination code in tables p.29 to 31 (1st contact - 2nd contact - Fiber Optic cable) and the length of your assembly on 3 digits in meter (M) or centimetre (CM). You must use meter when possible (see examples above).

Harnesses - Recommended cables

SOURIAU offers a wide range of cables, from cost efficient to high performance aeronautical cables. Fast delivery!

Application	Standard	Cable code	Fiber type	Cable diameter	Temperature range	Tensile strength (N)	Number of ways	Bandwidth Limit (MHz.km)*	Attenuation (dB.km)*	Min. bend radius (mm)	Weight (kg.km)	Structure outer jacket
HIGH PERFORMANCE CABLES For flying use	ABS0963-003LF, EN4641-102	FCABLE11	62.5/125	1.8	-55°C to +125°C	250	1	400/1000	4.0/2.0	20	4	Tight
	ARINC802	FCABLE21	62.5/125	1.8	-55°C to +100°C	300	1	200/500	3.0/0.8	9	4.6	Semi-loose
	EN4641-101	FCABLE41	62.5/125	0.9	-55°C to +125°C	20	1	400/1000	4.0/2.0	10	1	NA
	-	FCABLE33	9/125	1.8	-55°C to +125°C	250	1	No limit	0.5/0.5	20	2.2	Tight
	EN4641-301, ABS2293 LG (50µm)	FCABLE22	50/125	1.8	-65°C to +135°C	200	1	400/1000	2.5/1.0	20	4	Tight
COST EFFICIENT CABLES For harsh environment	-	FCABLE61	62.5/125	1.8	-40°C to +85°C	130	1	200/500	3.5/1.5	25	2.2	Loose
	-	FCABLE42	50/125	1.8	-40°C to +85°C	130	1	1500/500	3.0/1.0	25	2.2	Loose
	-	FCABLE43	9/125	1.8	-40°C to +85°C	130	1	No limit	0.5/0.5	25	2.2	Loose
	-	FCABLE13	9/125	0.9	-40°C to +85°C	10	1	No limit	0.6/0.6	15	0.4	NA
	-	FCABLE31	62.5/125	1.6	-20°C to +70°C	200	1	200/500	3.5/1.0	30	4	Loose
	-	FCABLE12	50/125	1.8	-10°C to +70°C	200	1	1500/500	2.8/0.8	20	4	Loose
	-	FCABLE32	50/125	5.5	-40°C to +85°C	1800	4	500/500	2.8/0.8	55	21	Tight
	-	FCABLE23	9/125	5	-40°C to +85°C	2000	4	No limit	0.6/0.6	50	28	Tight

* 1st value @850nm for multimode cable, 2nd value @1300nm for multimode (respectively 1300nm and 1550nm for singlemode)
ELIO® is compatible with loose and tight structured cables. Tactical breakout cables are compatible with ELIO® with use of backshells.

Consult us for other harsh environment cables.

Standard length tolerances

Patchcord from 30 cm to 1 m	0 / + 5 cm
Patchcord from 1 m to 4 m	0 / + 10 cm
Patchcord from 4 m to 15 m	0 / + 20 cm
Patchcord > 15 m	0 / + 30 cm

Patchcord combination code

Most common cables with most common contacts - For other combinations please consult us.
All contact are UPC polished otherwise specified.

With cable FCABLE11

Contact 2 \ Contact 1	ST	SC	ARINC801 1.25mm	LC Simplex	ELIO18WGS	ELIO18WGLA	ELIO18NGSA	ELIO18NGNA	ELIO18NGLA
ELIO18NGLA	0350	0349	0533	0348	0183	0114	0347	0186	0346
ELIO18NGNA	0206	0215	0534	0211	0195	0190	0221	0220	
ELIO18NGSA	0207	0216	0535	0212	0196	0191	0222		
ELIO18WGLA	0107	0110	0251	0109	0188	0111			
ELIO18WGS	0192	0194	0254	0193	0116				
LC Simplex	0203	0209	0536	0208					
ARINC801 1.25mm	0538	0537	0263						
SC	0204	0213							
ST	0124								

With cable FCABLE13

Contact 2 \ Contact 1	ST	SC	ARINC801 1.25mm	LC Simplex	FC	ELIO09NESA	ELIO09NENA	ELIO09NELA
ELIO09NELA	0561	0560	0633	0559	0558	0675	0674	0551
ELIO09NENA	0564	0563	0632	0550	0562	0676	0552	
ELIO09NESA	0568	0567	0631	0566	0565	0553		
FC	0679	0678	0630	0677	0554			
LC Simplex	0681	0680	0629	0555				
ARINC801 1.25mm	0683	0682	0628					
SC	0684	0556						
ST	0557							

With cable FCABLE31

Contact 2 \ Contact 1	ST	SC	ARINC801 1.25mm	LC Simplex	FC	ELIO18NGSA	ELIO18NGNA	ELIO18NGLA
ELIO18NGLA	0345	0344	0641	0343	0342	0341	0153	0340
ELIO18NGNA	0166	0175	0640	0171	0178	0181	0180	
ELIO18NGSA	0167	0176	0639	0172	0179	0182		
FC	0165	0174	0636	0170	0177			
LC Simplex	0163	0169	0635	0168				
ARINC801 1.25mm	0686	0685	0634					
SC	0164	0173						
ST	0162							

With cable FCABLE41

Contact 2 \ Contact 1	ST	SC	ARINC801 1.25mm	LC Simplex	FC	ELIO09NGSA	ELIO09NGNA	ELIO09NGLA
ELIO09NGLA	0226	0227	0647	0103	0228	0229	0230	0126
ELIO09NGNA	0529	0239	0646	0235	0242	0244	0245	
ELIO09NGSA	0530	0238	0645	0234	0241	0243		
FC	0240	0237	0644	0233	0687			
LC Simplex	0531	0232	0643	0231				
ARINC801 1.25mm	0689	0688	0642					
SC	0532	0236						
ST	0253							

With cable FCABLE43

Contact 2 \ Contact 1	ST	SC/UPC	SC/APC	ARINC801 1.25mm	LC Simplex/UPC	LC Simplex/APC	FC/UPC	FC/APC	ELIO18WESA	ELIO18WELA	ELIO18NESA	ELIO18NENA	ELIO18NELA
ELIO18NELA	0464	0457	0449	0673	0443	0437	0433	0429	0425	0422	0420	0419	0409
ELIO18NENA	0465	0458	0450	0672	0444	0438	0434	0430	0426	0423	0421	0410	
ELIO18NESA	0466	0459	0451	0671	0445	0439	0435	0431	0427	0424	0411		
ELIO18WELA	0467	0460	0452	0670	0353	0440	0408	0432	0428	0356			
ELIO18WESA	0468	0461	0453	0669	0446	0441	0436	0367	0366				
FC/APC	X	X	0454	0668	X	0442	X	0412					
FC/UPC	0470	0462	X	0667	0447	X	0413						
LC Simplex/APC	X	X	0455	0666	X	0414							
LC Simplex/UPC	0472	0463	X	0665	0415								
ARINC801 1.25mm	0695	0694	0456	0664									
SC/APC	X	X	0416										
SC/UPC	0474	0417											
ST	0418												

Note: For other combination cable/contacts please send a request to contactmilaero@souriau.com

With cable FCABLE21

Contact 2 \ Contact 1	Contact 2									
	ST	SC	FC	ARINC801 1.25mm	LC Simplex	ELIO18WGS A	ELIO18WGL A	ELIO18NGS A	ELIO18NGN A	ELIO18NGL A
ELIO18NGLA	0696	0706	0715	0723	0730	0736	0741	0745	0748	0750
ELIO18NGNA	0697	0707	0716	0724	0731	0737	0742	0746	0749	
ELIO18NGSA	0698	0708	0717	0725	0732	0738	0743	0747		
ELIO18WGLA	0699	0709	0718	0726	0733	0739	0744			
ELIO18WGSA	0700	0710	0719	0727	0734	0740				
LC Simplex	0701	0711	0720	0728	0735					
ARINC801 1.25mm	0702	0712	0721	0729						
FC	0703	0713	0722							
SC	0704	0714								
ST	0705									

With cable FCABLE22

Contact 2 \ Contact 1	Contact 2									
	ST	SC	FC	ARINC801 1.25mm	LC Simplex	ELIO18WGS A	ELIO18WGL A	ELIO18NGS A	ELIO18NGN A	ELIO18NGL A
ELIO18NGLA	0582	0591	0599	0606	0612	0617	0621	0624	0626	0627
ELIO18NGNA	0581	0590	0598	0605	0611	0616	0620	0623	0625	
ELIO18NGSA	0580	0589	0597	0604	0610	0615	0619	0622		
ELIO18WGLA	0579	0588	0596	0603	0609	0614	0618			
ELIO18WGSA	0578	0587	0595	0602	0608	0613				
LC Simplex	0577	0586	0594	0601	0607					
ARINC801 1.25mm	0576	0585	0593	0600						
FC	0575	0584	0592							
SC	0574	0583								
ST	0570									

With cable FCABLE42

Contact 2 \ Contact 1	Contact 2									
	ST	SC	ARINC801 1.25mm	LC Simplex	FC	ELIO18WGS A	ELIO18WGL A	ELIO18NGS A	ELIO18NGN A	ELIO18NGL A
ELIO18NGLA	0491	0490	0663	0489	0488	0487	0486	0485	0484	0475
ELIO18NGNA	0498	0497	0662	0496	0495	0494	0493	0492	0476	
ELIO18NGSA	0504	0503	0661	0502	0501	0500	0499	0477		
ELIO18WGLA	0508	0507	0660	0113	0506	0505	0478			
ELIO18WGSA	0512	0511	0659	0510	0509	0479				
FC	0515	0514	0658	0513	0480					
LC Simplex	0517	0516	0657	0481						
ARINC801 1.25mm	0693	0692	0656							
SC	0518	0482								
ST	0483									

With cable FCABLE61

Contact 2 \ Contact 1	Contact 2									
	ST	SC	ARINC801 1.25mm	LC Simplex	FC	ELIO18WGS A	ELIO18WGL A	ELIO18NGS A	ELIO18NGN A	ELIO18NGL A
ELIO18NGLA	0384	0383	0655	0382	0381	0404	0401	0398	0397	0372
ELIO18NGNA	0522	0521	0654	0520	0519	0405	0402	0399	0373	
ELIO18NGSA	0388	0387	0653	0386	0385	0406	0403	0374		
ELIO18WGLA	0392	0391	0652	0390	0389	0407	0375			
ELIO18WGSA	0396	0395	0651	0394	0393	0376				
FC	0525	0524	0650	0523	0377					
LC Simplex	0527	0526	0649	0378						
ARINC801 1.25mm	0691	0690	0648							
SC	0528	0379								
ST	0380									

With cable FCABLE33

Contact 2 \ Contact 1	Contact 2												
	ST	SC/UPC	SC/APC	ARINC801 1.25mm	LC Simplex/UPC	LC Simplex/APC	FC/UPC	FC/APC	ELIO18WESA	ELIO18WELA	ELIO18NESA	ELIO18NENA	ELIO18NELA
ELIO18NELA	0763	0762	0761	0760	0759	0758	0757	0756	0755	0754	0753	0752	0751
ELIO18NENA	0775	0774	0773	0772	0771	0770	0769	0768	0767	0766	0765	0764	
ELIO18NESA	0786	0785	0784	0783	0782	0781	0780	0779	0778	0777	0776		
ELIO18WELA	0796	0795	0794	0793	0792	0791	0790	0789	0788	0787			
ELIO18WESA	0805	0804	0803	0802	0801	0800	0799	0798	0797				
FC/APC	X	X	0811	0810	X	0808	X	0806					
FC/UPC	0820	0819	X	0817	0816	X	0814						
LC Simplex/APC	X	X	0824	0823	X	0821							
LC Simplex/UPC	0831	0830	X	0828	0827								
ARINC801 1.25mm	0835	0834	0833	0832									
SC/APC	X	X	0836										
SC/UPC	0840	0839											
ST	0841												

With cable FCABLE12

Contact 2 \ Contact 1	Contact 2						
	ST	SC	LC Simplex	FC	ELIO18WGS A	ELIO18WGL A	ELIO18NGN A
ELIO18NGNA			0310				
ELIO18WGLA	0267		0284	0285		0260	
ELIO18WGSA	0270	0269	0300	0301			
FC							
LC Simplex							
SC							
ST	0286						

Note: For other combination cable/contacts please send a request to contactmilaero@souriau.com

ELIO® FIBER OPTIC

Tooling & Accessories

■ Insertion & Extraction tool	34
■ Filler plug & Dummy contact	34
■ ELIO® adaptor for ST polishing fixture	34
■ ELIO® coupler.....	35
■ ELIO® mechanical splice.....	35
■ Universal test connector.....	35
■ ELIO® end face inspection tool	36
■ ELIO® blind inspection tool	37
■ ELIO® cleaning tool	37

Insertion & extraction tool

The insertion & extraction tool for ELIO® contact **with** boot is compatible with previous and new ELIO® contact versions.

80WV0059A



The insertion & extraction tool for ELIO® contact **without** boot is compatible with previous and new ELIO® contact versions.

80WV0060A



Filler plug & Dummy contact

MIL-DTL-38999 Series III/EN3645 - for high density cavities

Male filler plug
ELIOAFPP



Female filler plug
ELIOAFPS



ARINC 600 Series - for Quadrax #8 cavities

Male dummy contact
ELIOA001



Female dummy contact
ELIOA002



ELIO® adaptor for ST polishing fixture

With this adaptor, turn your ELIO® contact into an ST contact and save costs using standard ST polishing fixture.
Part Number: ELIOAST



ELIO® coupler



The ELIO® coupler is a tool used to measure optical losses of multimode and singlemode ELIO® jumpers without introducing a bias in the measurement due to the connector's influence and without having to pull on the cable to remove the contact from the tool.

Delivered with dust caps. NOT FOR USE IN FLIGHT.

Part number: **ELIOTELIOA**

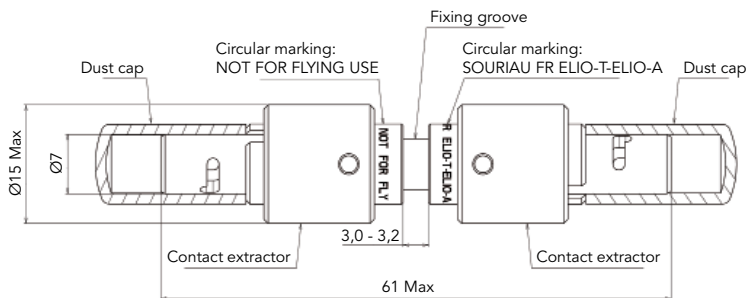

The operating instructions and the cleaning instructions are described in **BT255A** Instruction sheet.

Note: All dimensions are in millimeters (mm)

ELIO® mechanical splice



ELIO® sealed contacts terminated with the ELIO® cabling kit and connected through the ELIO® mechanical sleeve is a reliable and sealed solution to repair damaged optical links.

Part number: **ELIOELIO**

Note: Heatshrink boot and ELIO® contacts to be ordered separately.

Universal test connector



This connector can be connected to any other polarization. Ideal to limit the number of test leads.
The connector is customized with a green band and with a red band on the main polarization key to facilitate the mating.

Build your part number using the polarization letter «U»

NOT FOR USE IN FLIGHT.

	8D	0	E	11	F	02	AU
Shell type:							
5: Plug							
0: Square flange receptacle							
Designation:							
E: ELIO® optical connector							
Shell size:							
09 - 11 - 15 - 13 - 19 - 21 - 25							
Material & Plating:							
F: Aluminum nickel plated							
Layouts:	See page 14						
Insert type:							
AU: Male insert							
BU674: Female insert with ceramic alignment sleeves							

ELIO® end face inspection tool



SOURIAU and JDSU teamed to develop a contact end face inspection tool suitable for use with ELIO® / EN4531 / ARINC801 technology. Inspect before you connect.

Proactive inspection and cleaning can prevent poor signal performance and permanent damage to the contact end face.

The inspection tools can be bought through SOURIAU using the SOURIAU part numbers and directly through JDSU using the JDSU part numbers.

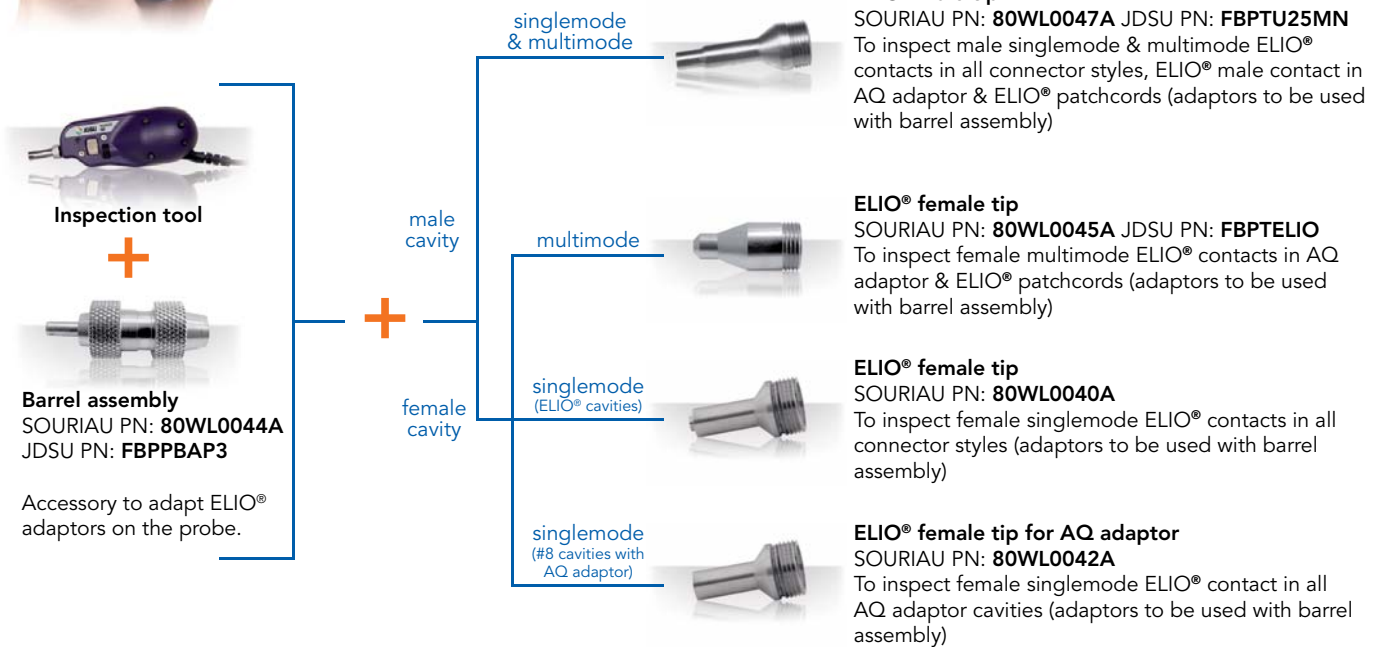

Rugged contact inspection kit

Datasheet and user manual available at: jdsu.com/inspect
SOURIAU PN: 80ML0001A JDSU PN: FBPELIO1
Dual magnification (200x/400x) probe and small rugged handheld display.

- Contents:
- + HD3 display
 - + 200/400x FBP analog probe
 - + barrel assembly FBPP-BAP3
 - + female ELIO adaptor FBPT-ELIO
 - + male ELIO adaptor FBPT-U25M-N
 - + soft case



Automated contact inspection kit

Data sheet and user manual available at: jdsu.com/inspect
SOURIAU PN: 80ML0002A JDSU PN: FBPELIO2
Kit to be used with a PC or laptop to determine the acceptability of optical end face through automated inspection and analysis.

- Contents:
- + 200/400x P5000 digital probe
 - + barrel assembly FBPP-BAP3
 - + female ELIO adaptor FBPT-ELIO
 - + male ELIO adaptor FBPT-U25M-N
 - + soft case



ELIO® blind inspection tool



The **blind inspection tool** is developed for faster and safer termini inspection in mass production environment and field use.

- **Fast:** It enables blind inspection thanks to a long guiding. Same inspection tip for the female and male insert.
- **Safe:** There is no risk of damaging with the probe tip the close-by termini or a ferrule.
- **User friendly:** Control with one hand. The tool remains fixed on the connector during inspection.

The blind inspection tool is delivered by Kit for each layout, consisting of male and female puck. The Blind inspection tool is dedicated to MIL-DTL-38999 Series III/EN3645 with ELIO® high insert density.



Layout 11-02
Kit Part Number: **80WL0036**



Layout 13-04
Kit Part Number: **80WL0037**



Layout 19-08
Kit Part Number: **80WL0038**



Layout 21-12
Kit Part Number: **80WL0043**
Limited availability, please consult us.



Layout 25-24
Kit Part Number: **80WL0039**



ELIO® cleaning pen

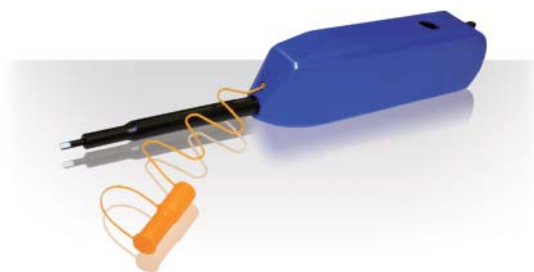

Standard cleaning pen for 2.5mm ceramic termini

- Simple pushing motion to engage tool
- Audible CLICK to alert operator when tool is fully engage
- Dry & large cleaning strand eliminates the need for solvents to be effective
- Contaminates such as alcohol, water, skin oil, vegetable and hand lotion residue as well as graphite and t-shirt lint are lifted from the connector end face

Souriau recommends IBC™ Brand Cleaner M250 from USConec for cleaning the ELIO® termini.

ELIO® FIBER OPTIC

Range Extension

■ 8XE Series with ELIO® contacts	40
■ VGE1 Series with ELIO® contacts	40
■ ELIO® fiber optic hermetic	41
■ Optical connectors website	42
■ ELIO® training	42

Product Range Extension

8XE Series with ELIO® Contacts

The ELIO® optical technology fits now the 8XE range to offer a ruggedized fiber optics for geophysics, oil & gas, offshore applications.

8XE Series = Overmolded 851 Series:

- . High impact glass filled plastic offering a great impact & shock resistance as well as an ergonomic shape of the coupling ring.
- . Suitable backshell in same plastic material allows IP68 sealing level.

High performance:

- . High impact & shock resistance: drop & crush resistance.
- . Easy, reliable & secure mating.
- . Excellent sealing performance: IP68 (120 hours under 15m water) / IP69K.
- . High salt spray resistance.



VGE1 Series with ELIO® Contacts

Rugged Fibre Optic Solutions for Railways.
The solution for very high speed data transmission in parasitized environment.

Reliable to railway standards. Tested according to:

- . Fire & smoke standards (NFF61030).
- . ELIO® optical contact, field proven over 10 years.

Easy to install:

- . No tool needed.

Standard connector:

- . Same shell as electrical version according to VG95234.

Fibre versatility:

- . Contacts designed for singlemode and multimode fibre.



See «VGE1 ELIO® Rugged Fiber Optic Solutions» product news on www.railway-connectors.com

Product Range Extension

ELIO® Fiber Optic Hermetic

Hermetic receptacles or feedthrough based on 38999 shells, intermateable with 38999 Series III plug populated ELIO® contacts.

Truly hermetic:

- . Leak rate: $< 10^{-9}$ atm.cm³/s.
- . Temperature range: -55°C to 200°C.

Wide range of layouts:

- . From 1 to 24 fiber optic channels.

Customs:

- . Versatile technology that can be adapted to your needs.



Optical connectors website

Visit our dedicated website:

www.optical-connectors.com

- Fiber optics basics
- ELIO® system
- Markets presentation
- Products overview
- Catalogs
- Datasheets

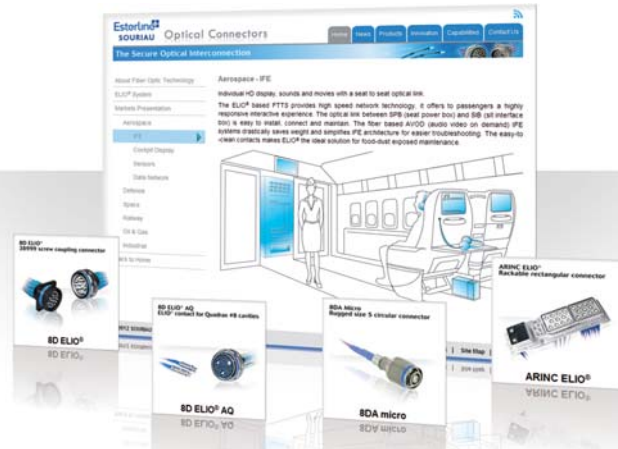

ELIO® training

Need to **strengthen** your global knowledge in optical fiber?

Need **support** for ELIO®'s use in the field?

Target your ELIO® training!

Souriau, in partnership with various training companies, offers training which can be adapted to your needs:



Installation module

3
DAYS

Fundamentals of fiber optics

Theoretical and **technological** aspects on the installation of **ELIO®** in an **aeronautical environment**, notably:

- Handling precautions
- Optical faces inspections
- On-board optical measurement processes

Practical applications

Cabling module

5
DAYS

Fundamentals of fiber optic

Theoretical and **technological** aspects on **ELIO®** contacts terminating, notably:

- Handling precautions
- ELIO® cabling process
- Control process by optical measurements

Terminating practical applications during two and a half days

For further information and a list of approved training companies, contact us at fiberoptics@souriau.com

Reliable People, Reliable Solutions



Your local contact



Our contribution to environmental protection:
This catalog is printed on PEFC certified paper
Advancement of sustainable wood cultivation. www.pefc.org

www.optical-connectors.com
contactmilaero@souriau.com

Esterline
Connection Technologies

SOURIAU