

SPACECRAFT COMPONENTS CORP.

Your Connector Consultant Since 1962

REVERSE BAYONET COUPLING CONNECTORS

DUST CAPS

& DUMMY RECEPTACLES

SCPB*TV/DCP19

SCPB*TF/DCR19

SCPB05/DRP19



▶ Special Platings Available

▶ Extensive Inventory



SPACECRAFT
COMPONENTS CORP.

DUST CAPS & DUMMY RECEPTACLES - REVERSE BAYONET

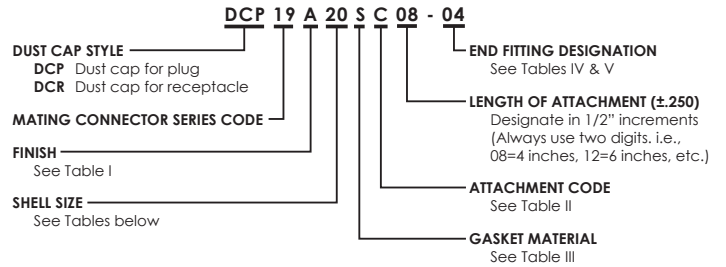
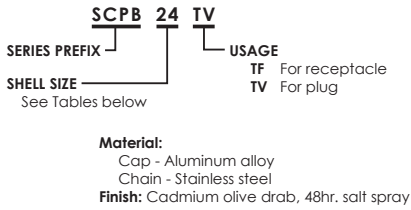

Dust Cap for Plug

SCP B*TV DCP19

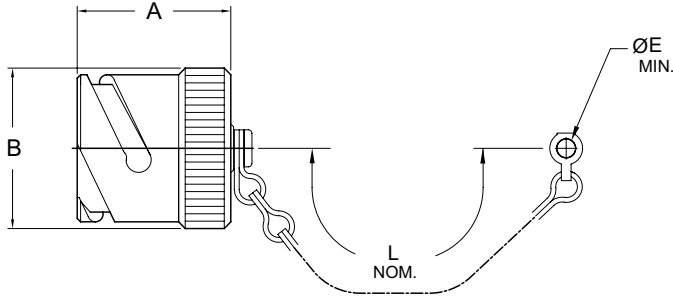

FOR PLUGS SCPB 06, 08, 064, 065

SHELL SIZE	A MAX.	B MAX.	E +0.5-0.25	L APPROX.
10SL	1.142 [29.0]	.827 [21.0]	0.173 [4.4]	4.252 [108]
14S	1.142 [29.0]	1.083 [27.5]	0.173 [4.4]	4.843 [123]
16S	1.142 [29.0]	1.181 [30.0]	0.173 [4.4]	4.843 [123]
16	1.457 [37.0]	1.181 [30.0]	0.173 [4.4]	4.843 [123]
18	1.457 [37.0]	1.319 [33.5]	0.173 [4.4]	4.843 [123]
20	1.457 [37.0]	1.457 [37.0]	0.189 [4.8]	5.433 [138]
22	1.457 [37.0]	1.575 [40.0]	0.189 [4.8]	5.433 [138]
24	1.457 [37.0]	1.713 [43.5]	0.189 [4.8]	5.433 [138]
28	1.457 [37.0]	1.949 [49.5]	0.189 [4.8]	8.110 [206]
32	1.457 [37.0]	2.205 [56.0]	0.220 [5.6]	8.110 [206]
36	1.457 [37.0]	2.461 [62.5]	0.220 [5.6]	8.110 [206]
40	1.457 [37.0]	2.665 [67.7]	0.220 [5.6]	8.110 [206]

1. DIMENSIONS IN BRACKETS [] ARE IN MILLIMETERS.

Dust Cap for Receptacle

SCP B*TF DCR19

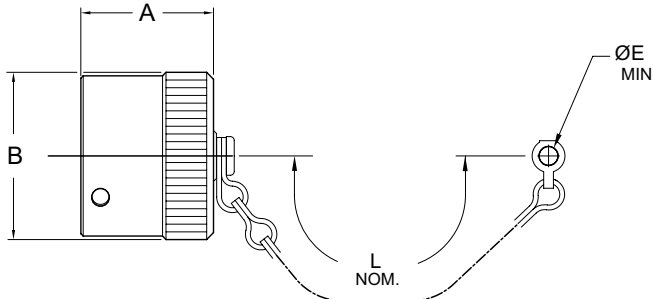

FOR RECEPTACLES
SCP B 00, 01 02, 03, 020, 030, 038, 07, 070, TB

SHELL SIZE	A MAX.	B MAX.	E +0.5-0.25	L APPROX.
10SL	0.787 [20.0]	.925 [23.5]	0.173 [4.4]	4.252 [108]
14S	0.787 [20.0]	1.201 [30.5]	0.173 [4.4]	4.252 [108]
16S	0.787 [20.0]	1.299 [33.0]	0.173 [4.4]	4.252 [108]
16	0.984 [25.0]	1.299 [33.0]	0.173 [4.4]	4.843 [123]
18	0.984 [25.0]	1.476 [37.5]	0.173 [4.4]	4.843 [123]
20	0.984 [25.0]	1.614 [41.0]	0.173 [4.4]	4.843 [123]
22	0.984 [25.0]	1.732 [44.0]	0.173 [4.4]	4.843 [123]
24	0.984 [25.0]	1.870 [47.5]	0.173 [4.4]	4.843 [123]
28	0.984 [25.0]	2.146 [54.5]	0.220 [5.6]	8.110 [206]
32	0.984 [25.0]	2.402 [61.0]	0.220 [5.6]	8.110 [206]
36	0.984 [25.0]	2.657 [67.5]	0.220 [5.6]	8.110 [206]
40	0.984 [25.0]	2.874 [73.0]	0.220 [5.6]	8.110 [206]

1. DIMENSIONS IN BRACKETS [] ARE IN MILLIMETERS.

Dummy Receptacle

SCP B05 DRP19

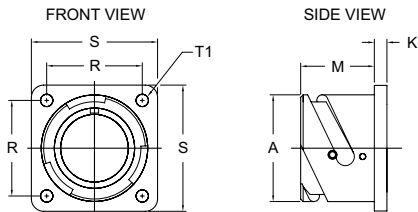
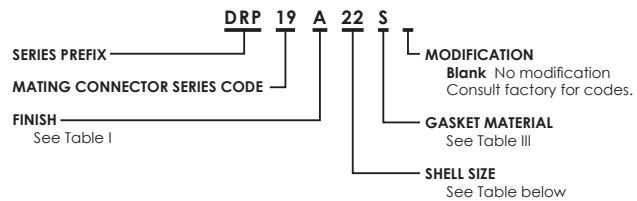
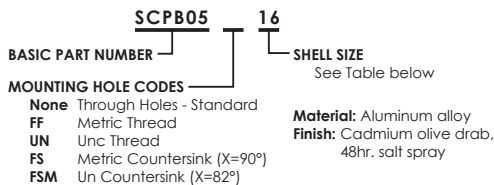

ENVIRONMENTAL WHEN USED WITH A FLANGE
SEALING GASKET SCP36675 OR SCP4050

MOUNTING HOLE OPTIONS

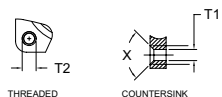

SHELL SIZE	FRONT VIEW						SIDE VIEW		
	R ±0.1	S ±0.3	T1 +0.1 -0.0	T2 THREAD		A +0.00-0.15	K ±0.2	M +0.4-0.0	
				METRIC	UNC				
10SL	0.717 [18.2]	1.000 [25.4]	0.126 [3.2]	M4	8-32UNC	0.717 [18.2]	0.110 [2.8]	0.559 [14.2]	
14S	0.906 [23.0]	1.181 [30.0]	0.126 [3.2]	M4	8-32UNC	0.969 [24.6]	0.126 [3.2]	0.559 [14.2]	
16S	0.969 [24.6]	1.280 [32.5]	0.126 [3.2]	M4	8-32UNC	1.079 [27.4]	0.126 [3.2]	0.559 [14.2]	
16	0.969 [24.6]	1.280 [32.5]	0.126 [3.2]	M4	8-32UNC	1.079 [27.4]	0.126 [3.2]	0.748 [19.0]	
18	1.063 [27.0]	1.378 [35.0]	0.126 [3.2]	M4	8-32UNC	1.213 [30.8]	0.157 [4.0]	0.748 [19.0]	
20	1.157 [29.4]	1.496 [38.0]	0.126 [3.2]	M4	8-32UNC	1.346 [34.2]	0.157 [4.0]	0.748 [19.0]	
22	1.252 [31.8]	1.614 [41.0]	0.126 [3.2]	M4	8-32UNC	1.472 [37.4]	0.157 [4.0]	0.748 [19.0]	
24	1.374 [34.9]	1.752 [44.5]	0.146 [3.7]	M4	10-24UNC	1.610 [40.9]	0.157 [4.0]	0.811 [20.6]	
28	1.563 [39.7]	2.000 [50.8]	0.146 [3.7]	M5	10-24UNC	1.839 [46.7]	0.157 [4.0]	0.811 [20.6]	
32	1.752 [44.5]	2.244 [57.0]	0.169 [4.3]	M5	1/4-20UNC	2.102 [53.4]	0.157 [4.0]	0.874 [22.2]	
36	1.937 [49.2]	2.500 [63.5]	0.169 [4.3]	M5	1/4-20UNC	2.346 [59.6]	0.157 [4.0]	0.874 [22.2]	
40	2.185 [55.5]	2.748 [69.8]	0.169 [4.3]	M5	1/4-20UNC	2.579 [65.5]	0.157 [4.0]	0.874 [22.2]	

1. DIMENSIONS IN BRACKETS [] ARE IN MILLIMETERS.



**SPACECRAFT
COMPONENTS CORP.**

3040 Clayton Street
North Las Vegas, NV 89032

Phone: 702.851.7600
Fax: 702.851.7620

Email: salesinfo@spacecraft.com
Web: www.spacecraft.com

REVERSE BAYONET - DUST CAPS & DUMMY RECEPTACLES

SPACECRAFT CODES FOR:
 DUST CAP FOR PLUG: **DCP19**
 DUST CAP FOR RECEPTACLE: **DCR19**
 DUMMY RECEPTACLE: **DRP19**

TABLE I. FINISH CODES
 CONSULT FACTORY FOR OTHER AVAILABLE FINISHES

Spacecraft Code	Finish	Specification(s)
H	● Anodize, Black	AMS-A-8625, Type II, Class 2
B	● Cadmium Plate, Black	AMS-QQ-P-416, Type II, Class 3
X	● Cadmium Plate, Bright Over Electroless Nickel	AMS-QQ-P-416, Type I, Class 3 ASTMB 733-90, SC2, Type I, Class 5 over AMS-C-26074, Class 4, Grade B
E	● Cadmium Plate, Gold Iridite, Over Electroless Nickel	MIL-C-5541, Class 3 AMS-QQ-P-416, Type II, Class 3 over AMS-C-26074, Class 4, Grade B
C	● Cadmium Plate, Olive Drab	AMS-QQ-P-416, Type II, Class 3, 48 Hours
A	● Cadmium Plate, Olive Drab Over Electroless Nickel	1000 Hour Corrosion Resistance
N	● Electroless Nickel	AMS-C-26074, Class 4, Grade B
L	● Zinc Cobalt, Dark Olive Drab	96 Hour Corrosion Resistance
P	● Passivated, Stainless Steel	AMS-QQ-P-35
T	● Nickel, Fluorocarbon Polymer	500 Hour Corrosion Resistance
W	● Zinc Nickel, Black	ASTM B841 Type D

TABLE II. ATTACHMENT CODES

Attachment Code	Description
A	No Attachment Required
B	Bead Chain, Brass, Nickel Plated
C	Sash Chain, SST, Passivated
D	Bead Chain, SST, Passivated
E	Bead Chain, Brass, Cadmium, Olive Drab Plated
F	Bead Chain, Brass, Unfinished
I	Bead Chain, Brass, Black Oxide Finish
R	Wire Rope, SST, PVC Covered, Green Color
T	Wire Rope, SST, Teflon Covered, Natural Cover
U	Wire Rope, SST, Nylon Covered, Brown Color
V	Wire Rope, SST, Viton Covered, Black Color
W	Nylon Cord, Green Color, SST Terminal

TABLE III. GASKET MATERIAL CODES

Material Code	Material Description
A	Fluorosilicone, Blue
N	Neoprene, Black, MIL-R-3065
O	None Required
S	Silicone, Red, ZZ-R-765
C	Conductive Silicone

TABLE IV. EYELET END FITTING STYLES AND SIZES
 (NOT USED WITH ATTACHMENT CODE A)

Dash No. Code	Y Ref. Dia.
00	No Eyelet
01	.125
02	.141
03	.167
04	.188
05	.219
06	.250
07	.156
08	.121

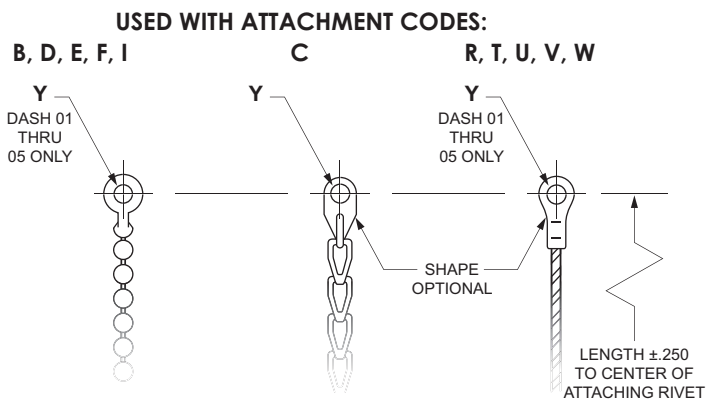
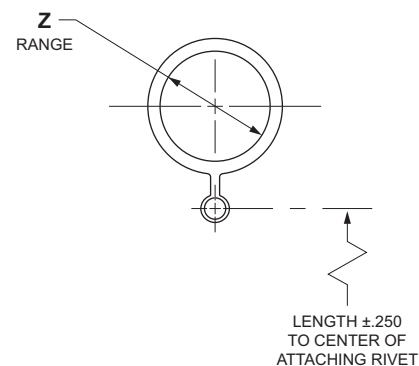

TABLE V. RING END FITTING SIZES
 (NOT USED WITH ATTACHMENT CODE A)

DASH NO. CODE	Z RANGE	DASH NO. CODE	Z RANGE	DASH NO. CODE	Z RANGE
33	.401 - .391	15	1.072 - 1.052	24	2.088 - 2.078
34	.454 - .444	16	1.198 - 1.178	25	2.151 - 2.141
35	.464 - .454	17	1.322 - 1.302	26	2.276 - 2.266
36	.526 - .516	18	1.448 - 1.428	27	2.338 - 2.328
11	.604 - .584	19	1.572 - 1.552	28	2.401 - 2.391
37	.651 - .641	20	1.698 - 1.678	29	2.526 - 2.516
12	.729 - .709	21	1.822 - 1.802	30	2.651 - 2.641
13	.885 - .865	22	1.948 - 1.928	31	2.901 - 2.891
14	.948 - .918	23	2.026 - 2.016	32	3.026 - 3.016

USED WITH ATTACHMENT CODES:
 B THRU W



SPACECRAFT COMPONENTS CORP.

Your Connector Consultant Since 1962



SCP 5015 STYLE CONNECTORS (CATALOG 102)



SCPT 26482 STYLE SC1 38999 SERIES I SC2 38999 SERIES II SC39 38999 SERIES III (CATALOG 202)



SCPB SERIES (CATALOG 302)



CONNECTOR ACCESSORIES (CATALOG 401)



CONNECTORS WITH INTEGRATED BACKSHELLS (CATALOG 601)

Try our other connector products.

COMING SOON... All Plastic Connectors CATALOG 701



SPACECRAFT COMPONENTS CORP.



Headquarters

3040 Clayton Street
North Las Vegas, NV 89032

Phone: 702.851.7600
Fax: 702.851.7620

Email: salesinfo@spacecraft.com
Web: www.spacecraft.com

Florida Office

10732 NW 53rd St.
Sunrise, FL 33351
Tel: 954.748.4540
Fax: 954.748.4128

Arizona Office

519 W. Lone Cactus Dr.
Suite 401
Phoenix, AZ 85027
Tel: 623.580.1162
Fax: 623.580.1165

Italy Office

Spacecraft Components, sp A
Milan, Italy
+39 (335) 719.4512

Mexico Office

Av. Constituyentes 13-6 Col. Pueblo Nuevo
Queretaro, Qro 76900
+52 442 341 69 63

MAY 2012
SF-149

COMPILED AND PRODUCED BY SPACECRAFT COMPONENTS CORP.
©2012 SPACECRAFT COMPONENTS CORP., NORTH LAS VEGAS, NV 89032